

PRELIMINARY DATA SHEET

OLI920: Hybrid Smart Photovoltaic Optocoupler

Features

- Isolated MOSFET/IGBT gate drive
- Fast turn-off circuitry
- dV/dt protection circuitry
- Performance guaranteed over $-55\text{ }^{\circ}\text{C}$ to $+125\text{ }^{\circ}\text{C}$ ambient temperature range
- 2500 V_{DC} electrical isolation
- High open-circuit voltage
- High short-circuit current
- Small size for hybrid assembly
- High reliability construction
- Radiation tolerant

Description

The OLI920 consists of a pair of LEDs that are optically coupled to a dielectrically isolated photovoltaic diode array, packaged on a thick film ceramic substrate. When the LED is energized, the infrared emission is detected by the photovoltaic array and a DC output voltage is generated. This electrically isolated voltage can be used to drive the gates of Metal Oxide Semiconductor (MOS) devices. Additional control circuitry provides fast turn-off, protection for false turn-on, and gate protection.

Surface mounting can be accomplished with conductive epoxies or reflow soldering.

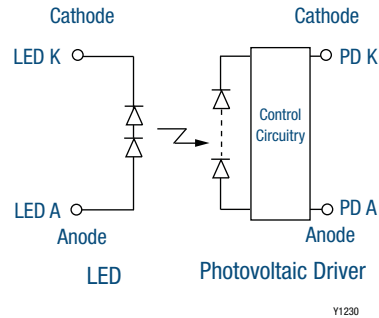

Figure 1. OLI920 Block Diagram

Figure 1 shows the OLI920 functional block diagram. Table 1 provides the OLI920 absolute maximum ratings. Table 2 provides the OLI920 electrical specifications.

Figures 2 through 6 illustrate the OLI920 typical performance characteristics. Figure 7 shows the OLI920 package dimensions.

Table 1. OLI920 Absolute Maximum Ratings (Note 1)

Parameter	Symbol	Minimum	Maximum	Units
Coupled				
Input to output isolation voltage (Note 2)	V _{DC}	-2500	+2500	V
Storage temperature range	T _{STG}	-65	+150	°C
Operating temperature range	T _A	-55	+125	°C
Mounting temperature range (3 minutes maximum)			+240	°C
Input Diode				
Average input current	I _{DD}		100	mA
Peak forward current (≤1 ms duration)	I _F		180	mA
Reverse voltage	V _R		5	V
Power dissipation	P _D		200	mW
Output Detector				
Forward voltage	V _F		14	V
Reverse voltage	V _R		1.5	V

Note 1: Exposure to maximum rating conditions for extended periods may reduce device reliability. There is no damage to the device with only one parameter set at the limit and all other parameters set at or below their nominal value. Exceeding any of the limits listed here may result in permanent damage to the device.

Note 2: Measured between LED pins shorted together and output pins shorted together. T_A = 25°C and duration = 1 s.

CAUTION: Although this device is designed to be as robust as possible, electrostatic discharge (ESD) can damage this device. This device must be protected at all times from ESD. Static charges may easily produce potentials of several kilovolts on the human body or equipment, which can discharge without detection. Industry-standard ESD precautions should be used at all times.

Table 2. OLI920 Electrical Specifications (Note 1)
(T_A = -55 °C to +125 °C, Unless Otherwise Noted)

Parameter	Symbol	Test Condition	Minimum	Typical	Maximum	Units
Open circuit voltage	V _{OC}	I _F = 10 mA	7.5	10		V
Short circuit current	I _{SC}	I _F = 10 mA	-7	-20		μA
Input:						
Forward voltage	V _F	I _F = 10 mA, T _A = 25 °C I _F = 10 mA, T _A = -55 °C I _F = 10 mA, T _A = 125 °C	2.4 2.8 2.2	2.8	3.4 3.85 3.0	V V V
Reverse breakdown voltage	B _{VR}	I _R = 10 μA	5			V
Output leakage current (Note 2)	I _{L_O}	R _H ≤50%, 1500 V _{DC} , T _A = 25 °C, Duration = 1 s			1	μA
Time:						
Turn-on	t _{ON}	I _F = 10 mA, PW = 100 μs, f = 1 kHz, C = 15 pf, T _A = 25 °C, R _L = 10 MΩ		60		μs
Turn-off	t _{OFF}	t _{ON} = 0% to 90% t _{OFF} = 100% to 10%		1		μs

Note 1: Performance is guaranteed only under the conditions listed in the above table.

Note 2: Measured between LED pins shorted together and output pins shorted together. T_A = 25°C and duration = 1 s.

Typical Performance Characteristics

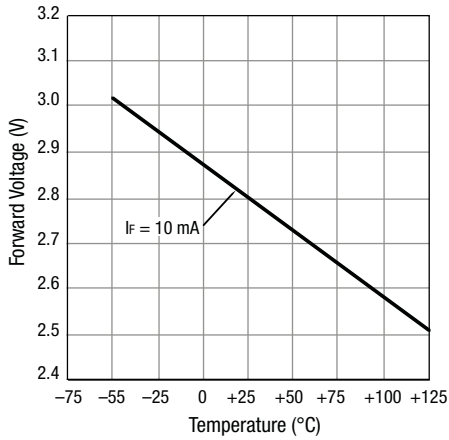

Figure 2. LED Forward Voltage vs Temperature

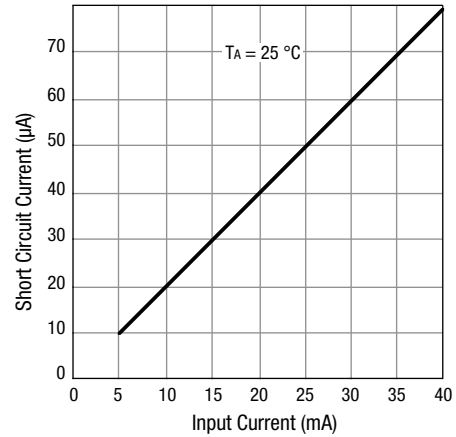

Figure 3. Short Circuit Current vs Input Current

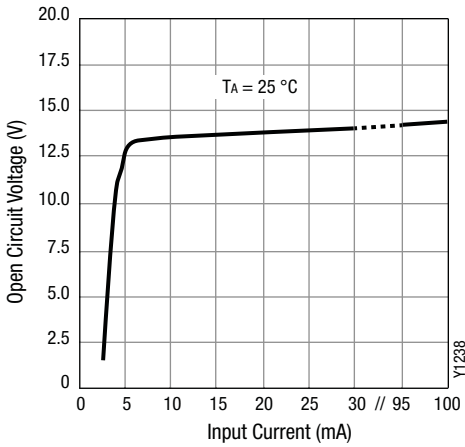

Figure 4. Open Circuit Voltage vs Input Current

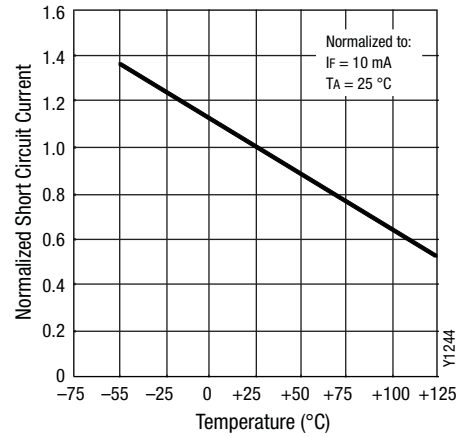

Figure 5. Normalized Short Circuit Current vs Temperature

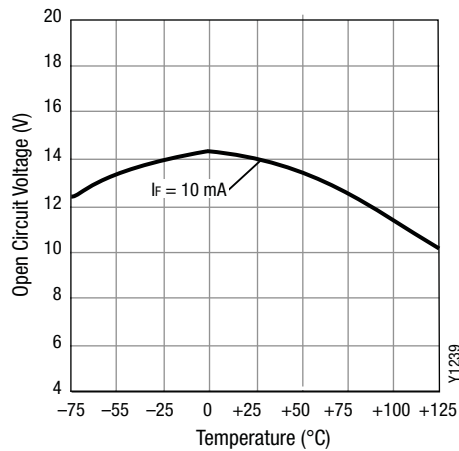
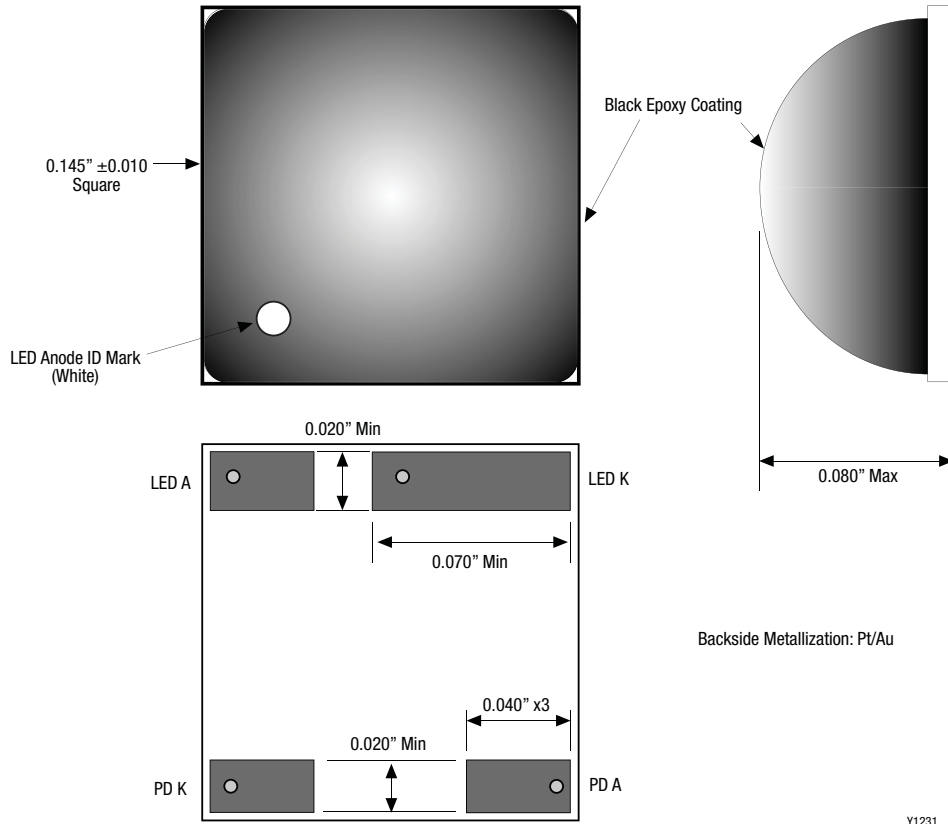

Figure 6. Open Circuit Voltage vs Temperature



Y1231

Figure 7. OLI920 Package Dimensions

Ordering Information

Model Name	Manufacturing Part Number
OLI920: Hybrid Smart Photovoltaic Optocoupler	OLI920

Copyright © 2014, 2017 Isolink, Inc. All Rights Reserved.

Information in this document is provided in connection with Isolink, Inc. ("Isolink"), a wholly-owned subsidiary of Skyworks Solutions, Inc. These materials, including the information contained herein, are provided by Isolink as a service to its customers and may be used for informational purposes only by the customer. Isolink assumes no responsibility for errors or omissions in these materials or the information contained herein. Isolink may change its documentation, products, services, specifications or product descriptions at any time, without notice. Isolink makes no commitment to update the materials or information and shall have no responsibility whatsoever for conflicts, incompatibilities, or other difficulties arising from any future changes.

No license, whether express, implied, by estoppel or otherwise, is granted to any intellectual property rights by this document. Isolink assumes no liability for any materials, products or information provided hereunder, including the sale, distribution, reproduction or use of Isolink products, information or materials, except as may be provided in Isolink Terms and Conditions of Sale.

THE MATERIALS, PRODUCTS AND INFORMATION ARE PROVIDED "AS IS" WITHOUT WARRANTY OF ANY KIND, WHETHER EXPRESS, IMPLIED, STATUTORY, OR OTHERWISE, INCLUDING FITNESS FOR A PARTICULAR PURPOSE OR USE, MERCHANTABILITY, PERFORMANCE, QUALITY OR NON-INFRINGEMENT OF ANY INTELLECTUAL PROPERTY RIGHT; ALL SUCH WARRANTIES ARE HEREBY EXPRESSLY DISCLAIMED. ISOLINK DOES NOT WARRANT THE ACCURACY OR COMPLETENESS OF THE INFORMATION, TEXT, GRAPHICS OR OTHER ITEMS CONTAINED WITHIN THESE MATERIALS. ISOLINK SHALL NOT BE LIABLE FOR ANY DAMAGES, INCLUDING BUT NOT LIMITED TO ANY SPECIAL, INDIRECT, INCIDENTAL, STATUTORY, OR CONSEQUENTIAL DAMAGES, INCLUDING WITHOUT LIMITATION, LOST REVENUES OR LOST PROFITS THAT MAY RESULT FROM THE USE OF THE MATERIALS OR INFORMATION, WHETHER OR NOT THE RECIPIENT OF MATERIALS HAS BEEN ADVISED OF THE POSSIBILITY OF SUCH DAMAGE.

Customers are responsible for their products and applications using Isolink products, which may deviate from published specifications as a result of design defects, errors, or operation of products outside of published parameters or design specifications. Customers should include design and operating safeguards to minimize these and other risks. Isolink assumes no liability for applications assistance, customer product design, or damage to any equipment resulting from the use of Isolink products outside of stated published specifications or parameters.

Isolink is a trademark of Isolink Inc. in the United States and other countries. Skyworks and the Skyworks symbol are trademarks or registered trademarks of Skyworks Solutions, Inc., in the United States and other countries. Third-party brands and names are for identification purposes only, and are the property of their respective owners.